

INFORMATION TABLE

Profile type	Visible element [mm]	Joint width [mm]	Base width [mm]	Installation height [mm]	Material type	Maximum load [kN]	Horizontal/Vertical compensation [mm]
EL 50.8.60	50	50	175	60	Aluminum, modified PVC	30	16(±8) 16(±8)

CONECTO EL 50.8.60
VIEW

CONECTO EL 50.8.60
SECTION

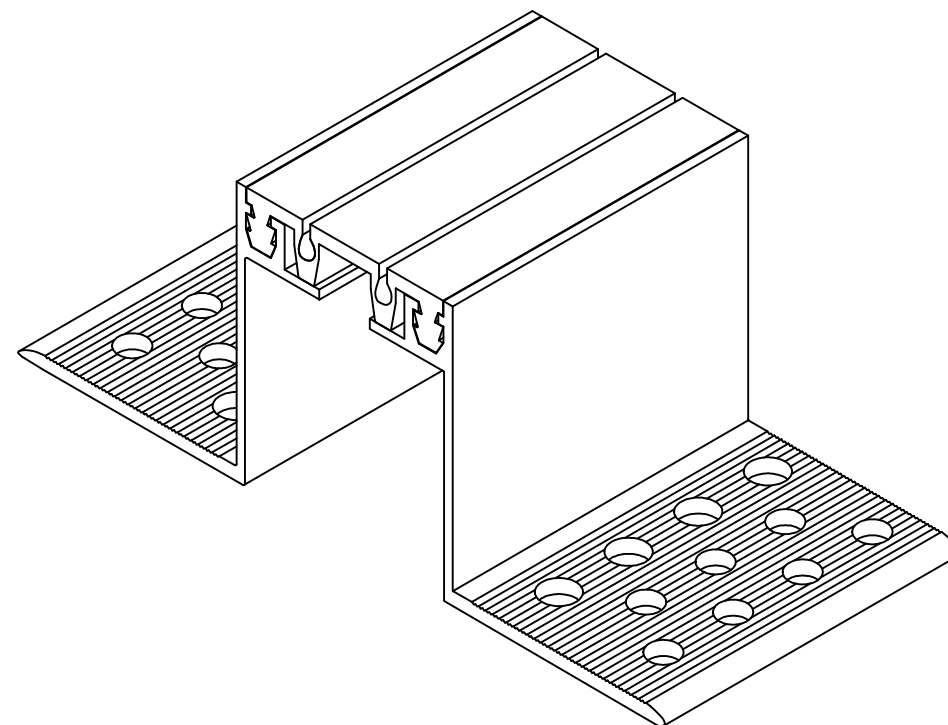
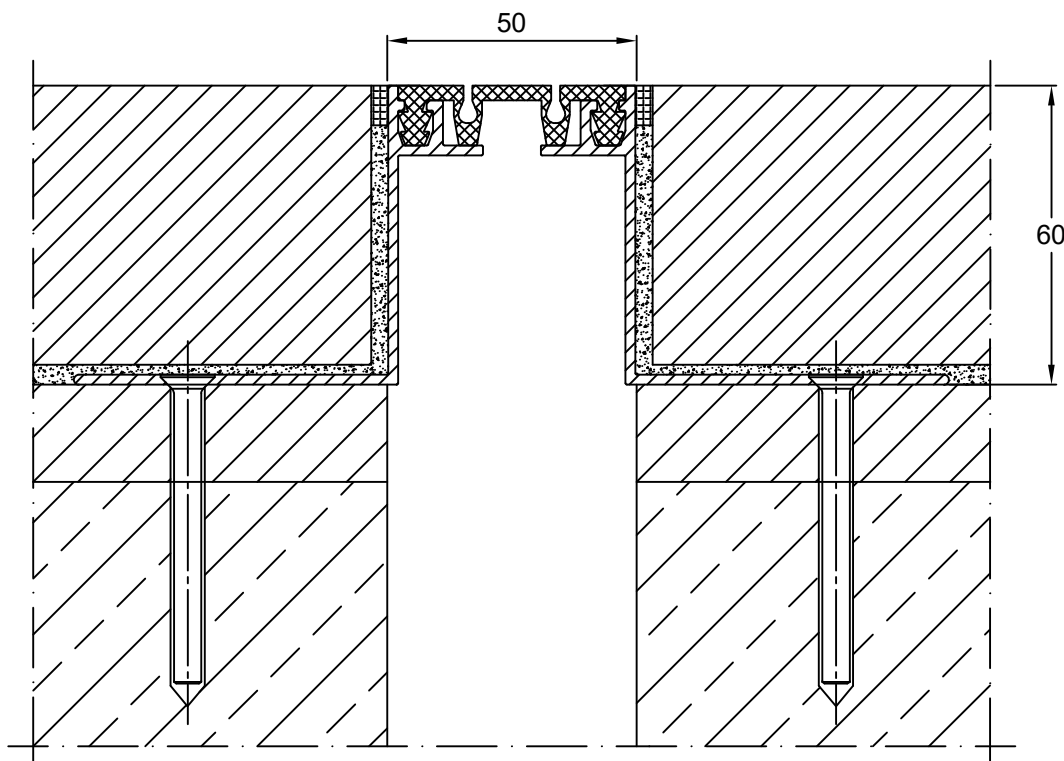

Expansion joint Conecto Elasto 50.8.60

Conecto Profiles Sp. z o.o.
ul. Przemysłowa 39
61-541 Poznań
www.conecto-profiles.com



ROZMIAR / SIZE A3	SKALA / SCALE 1:1	Wszystkie wymiary podano w [mm] All dimensions in [mm]
----------------------	----------------------	---

PROJEKT	PROJECT	ZŁOŻENIE	SUB ASSEMBLY	RYSUNEK	DRAWING	ARKUSZ SHEET	VER REV
--	--	--	--	01	01	1 Z OF 1	