

INFORMATION TABLE

Profile type	Visible element [mm]	Joint width [mm]	Base width [mm]	Installation height [mm]	Material type	Maximum load [KN]	Horizontal/vertical compensation [mm]
AL 78.10.42	78	max 50	194	42	Aluminum	100	20(±10) -16/+14

CONECTO AL 78.10.42
VIEW

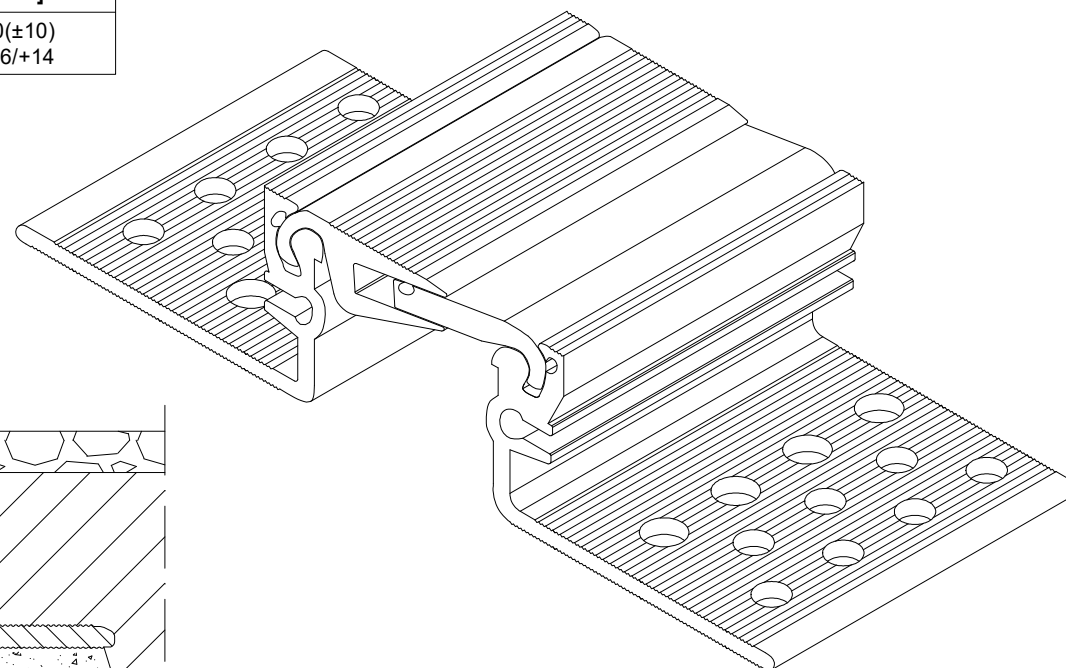

CONECTO AL 78.10.42
SECTION

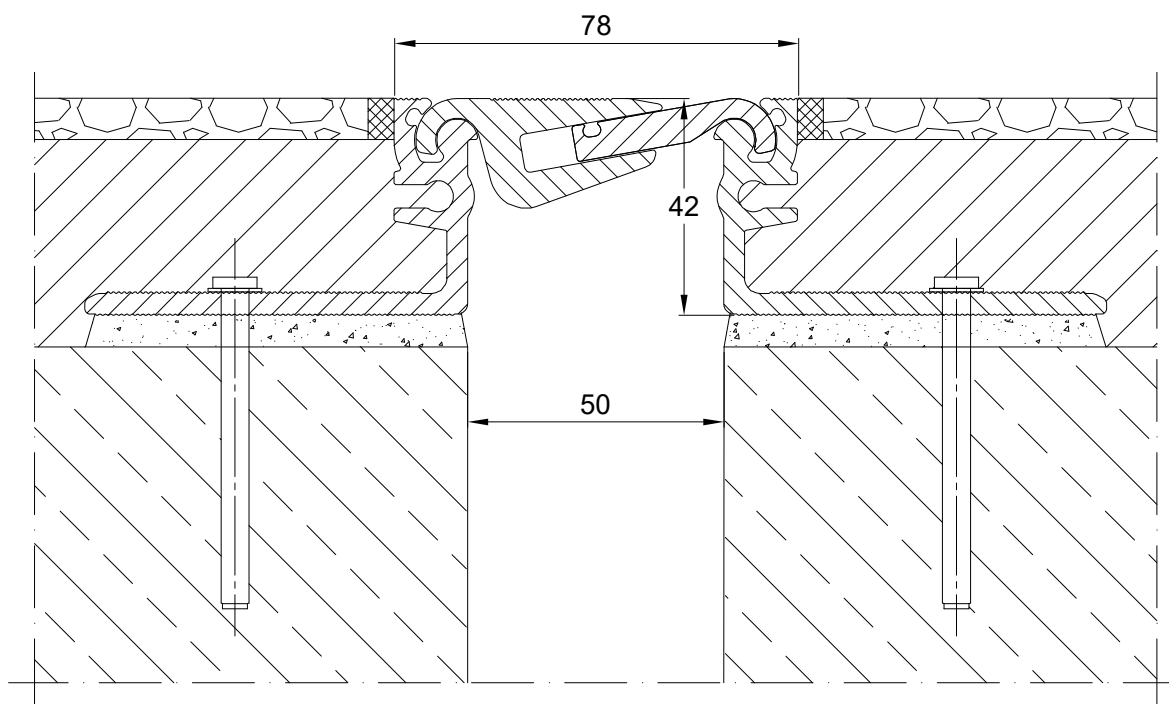

Expansion joint Conecto AL
78.10.42

Conecto Profiles Sp. z o.o.
ul. Przemysłowa 39
61-541 Poznań
www.conecto-profiles.com



ROZMIAR / SIZE A3	SKALA / SCALE 1:1	Wszystkie wymiary podano w [mm] All dimensions in [mm]
----------------------	----------------------	---

PROJEKT	PROJECT	ZŁOŻENIE	SUB ASSEMBLY	RYSUNEK	DRAWING	ARKUSZ	SHEET	WER	REV
--	--	--	--	01	01	1	Z OF	1	